

USER'S INFORMATION MANUAL

WARNING: If the information in this manual is not followed exactly, a fire or explosion may result causing property damage, personal injury or loss of life.

- Do not store or use gasoline or other flammable vapors and liquids in the vicinity of this or any other appliance.

- WHAT TO DO IF YOU SMELL GAS
 - Do not try to light any appliance.
 - Do not touch any electrical switch; do not use any phone in your building.
 - Immediately call your gas supplier from a neighbor's phone. Follow the gas supplier's instructions.
 - If you cannot reach your gas supplier, call the fire department.

- Installation and service must be performed by a qualified installer, service agency or the gas supplier.

1 - GENERAL

1.1 General

This boiler has few user serviceable parts. Maintenance and Service must be completed by qualified agency.

WARNING

Fire, explosion, asphyxiation and electrical shock hazard. Improper maintenance and service could result in death or serious injury. Read this manual and understand all requirements, including use of qualified agency where directed.

1.2 Become familiar with symbols identifying potential hazards.



This is the safety alert symbol. Symbol alerts you to potential personal injury hazards. Obey all safety messages following this symbol to avoid possible injury or death.

⚠ DANGER

Indicates a hazardous situation which, if not avoided, WILL result in death or serious injury

⚠ WARNING

Indicates a hazardous situation which, if not avoided, could result in death or serious injury.

⚠ CAUTION

Indicates a hazardous situation which, if not avoided, could result in minor or moderate injury.

NOTICE

Used to address practices not related to personal injury.

1.3 What To Do Should Overheating Occur

Do not turn off or disconnect electrical supply to pumps. Shut off gas supply at location external to appliance.

1.4 What To Do If Boiler Or Any Part Has Been Under Water

Do not use boiler if any part has been under water. Immediately call a qualified service technician to inspect boiler and to replace any part of control system and any gas control which has been under water.

2 - OPERATING INSTRUCTIONS

FOR YOUR SAFETY READ BEFORE OPERATING

⚠️ WARNING

If you do not follow these instructions exactly, a fire or explosion may result causing property damage, personal injury or loss of life.

- This appliance is equipped with an ignition device which automatically lights burner. **Do NOT try to light this burner by hand.**
- Before operating smell all around appliance area for gas. Be sure to smell next to floor because some gas is heavier than air and will settle to the floor.
- **Use only your hand to turn the gas shutoff valve.** Never use tools. If valve will not turn by hand, do not try to repair it, call a qualified service technician. Force or attempted repair may result in fire or explosion.
- **Do not use this appliance if any part has been under water.** Immediately call a qualified service technician to inspect appliance and to replace any part of control system and any gas control which has been under water.

2.1 OPERATING INSTRUCTIONS

Stop! Read Safety information above.

- Set thermostat to lowest setting.
- Turn "OFF" all electrical power to appliance.
- This appliance is equipped with an ignition device which automatically lights the burner. **Do not try to light burner by hand!**
- Remove front jacket panel.
- Turn gas shutoff valve clockwise to closed position. Handle should be perpendicular to gas pipe. See Figure 2-1
- Wait 5 minutes for any gas to clear. Smell for gas, including near floor. If you smell gas, **STOP!** Follow instructions on this page: "**What To Do If You Smell Gas.**" If you do **not** smell gas, go to next step.
- Turn gas shutoff valve counter clockwise to the open position. Handle should be parallel to gas pipe.
- Replace front jacket panel.
- Turn "ON" electrical power to appliance.
- Set thermostat to desired setting.
- If the appliance will not operate, follow instructions TO TURN OFF GAS TO APPLIANCE and call your service technician or gas supplier.

⚠️ CAUTION

WHAT TO DO IF YOU SMELL GAS

- Do not try to light any appliance.
- Do not touch any electrical switch; do not use any phone in your building.
- Immediately call your gas supplier from a neighbor's phone. Follow the gas supplier's instructions.
- If you cannot reach your gas supplier, call the fire department.

2.2 TO TURN OFF GAS TO APPLIANCE

- Set thermostat to lowest setting.
- Turn "OFF" all electric power to appliance if service is to be performed.
- Remove front jacket panel.
- Turn gas shutoff valve handle clockwise to closed position. Handle should be perpendicular to gas pipe.
- Replace front jacket panel.

2 -1 Gas Shutoff Valve

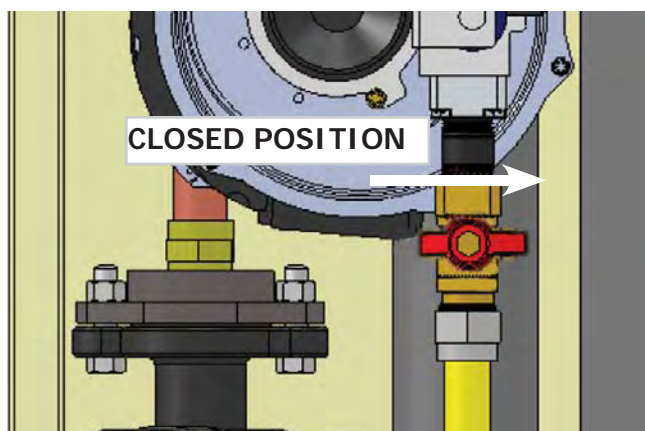
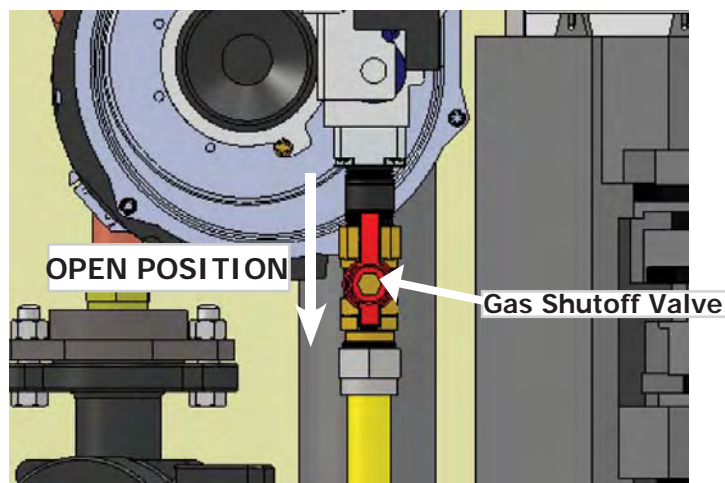

3 - FRONT PANEL STATUS INDICATORS

3.1 Front Panel Status Indicators

See Control Module Section for operational states of Front Panel Indicators and User Interface Display.

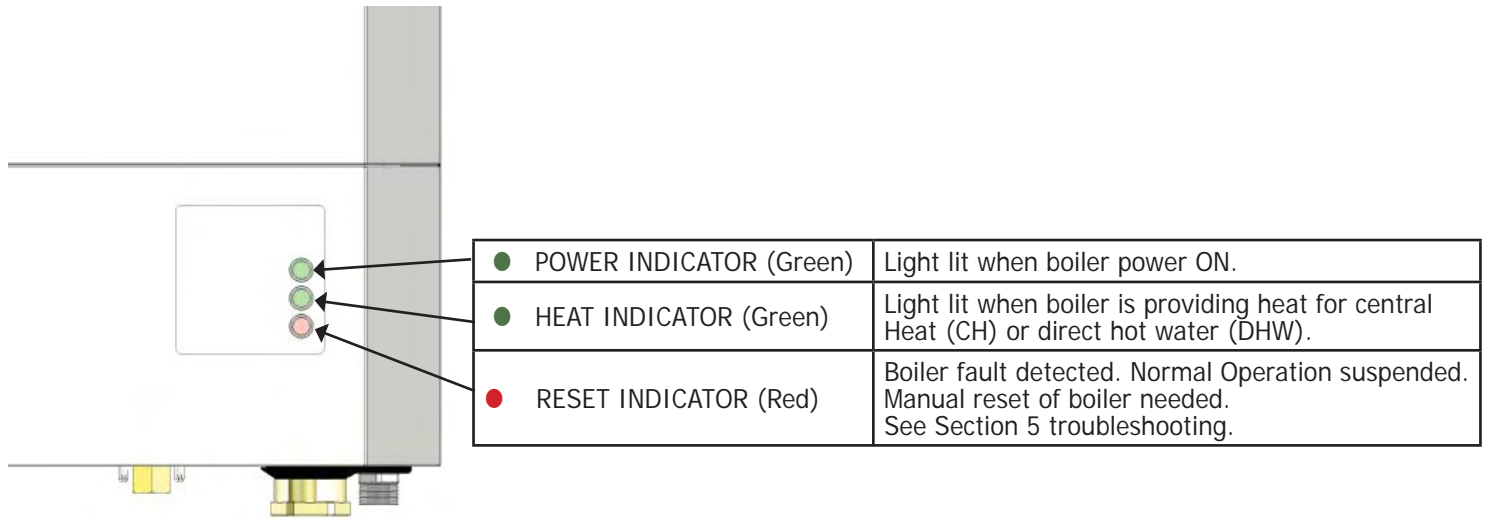





4 - CONTROL MODULE

4.1 Introduction

Boiler is equipped with programmable electronic control and user interface module.

Operation with LCD character display module

4.2 Operation

Key	Description
	- Manual Lockout Reset
	- Enter/Exit user menu - Go to previous screen
	- Select a menu item - Confirm new parameter value
	- Scroll up to next menu item - Increase value
	- Scroll down to next menu item - Decrease value

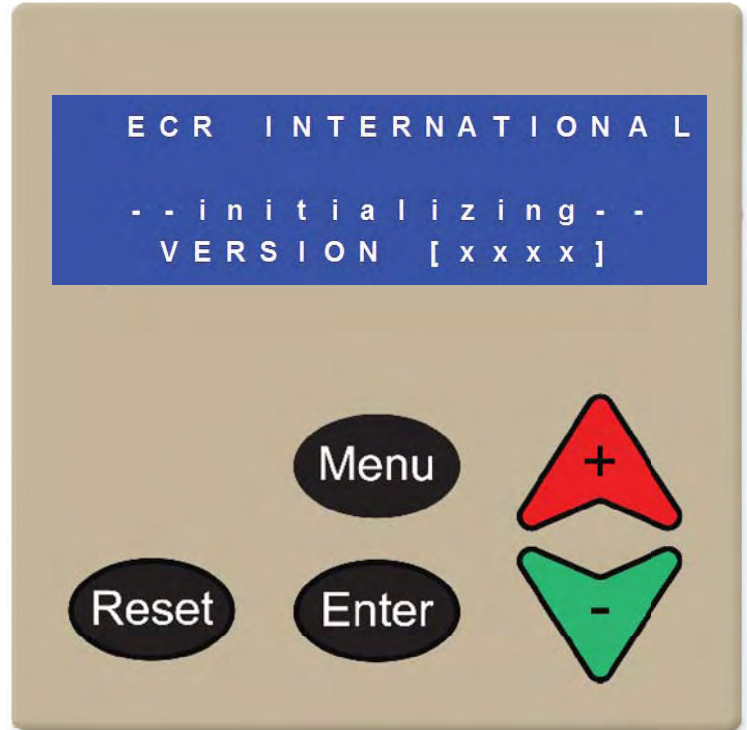

4.3 Status Indication

The following status screens can be displayed:

Boiler Status Indicator

- F = Flame Detected
- P = Central Heating/System Pump On
- B = Combustion Air Blower On
- S = Safety Relay Check
- G = Gas Valve Open
- D = DHW Pump On

```

F P B S G D
Service Reminder
Standby : No Demand
              75 ° F
    
```

- ← Service Reminder Indicator
- ← Boiler in Standby Mode
- ← Boiler Supply Water Temperature Indicator

Combustion Air Blower Speed Indicator

```

F P B G
Central Heating
65 %              95 ° F
    
```

- ← Boiler Running in Central Heat mode

```

F P B G D
Domestic Hot Water
95 %              165 ° F
    
```

- ← Boiler Running in DHW mode

```

Lockout Alarm A06
Safety Relay Error
    
```

- ← Lockout Alarm Indicator
Error code and short text description displayed.
Press Reset key for manual reset.



























```

Blocking Error E52
Return Sens Open
    
```

- ← Blocking Error
Error code and short text description displayed. Boiler automatically returns to Standby Mode when condition eliminated.





4 - CONTROL MODULE

4.4 Sequence of Operation

Operational State	Front Panel Status Indicators	User Interface Display	Explanation
<div style="border: 1px solid black; border-radius: 15px; padding: 5px; width: fit-content; margin: 0 auto;">Ready for Operation</div>	  	STANDBY: NO DEMAND 75 ° F	Boiler operates in standby mode until demand for Central Heat (CH) or Domestic Hot Water (DHW) detected.
<div style="border: 1px solid black; padding: 5px; width: fit-content; margin: 0 auto;">Thermostat Starts Call for Heat</div>	  	P _ _ _ _ CENTRAL HEATING 0 % 75 ° F	Call for heat. CH/System or DHW pump turned ON based on type of heating demand. Heat Exchanger Pump also turned ON. (CH demand illustrated)
<div style="border: 1px solid black; padding: 5px; width: fit-content; margin: 0 auto;">Pre-Purge</div>	  	PB _ _ _ CENTRAL HEATING 100 % 75 ° F	Combustion Air Blower energized.
<div style="border: 1px solid black; padding: 5px; width: fit-content; margin: 0 auto;">Trial for Ignition</div>	  	PB _ _ _ CENTRAL HEATING 65 % 75 ° F	Combustion Air Blower speed modulates to prepurge setting for 15 seconds.
<div style="border: 1px solid black; padding: 5px; width: fit-content; margin: 0 auto;">Trial for Ignition</div>	  	PBS _ _ CENTRAL HEATING 65 % 75 ° F	Igniter energized to start sparking sequence.
<div style="border: 1px solid black; padding: 5px; width: fit-content; margin: 0 auto;">Trial for Ignition</div>	  	PBSG _ CENTRAL HEATING 65 % 75 ° F	Gas Valve energized to deliver air/fuel to burner.
<div style="border: 1px solid black; padding: 5px; width: fit-content; margin: 0 auto;">Normal Operation</div>	  	FPB _ G _ CENTRAL HEATING 5 % 135 ° F	Igniter de-energized. Boiler runs provided all operational and safety devices within limits. Control Module adjusts firing rate to match heating demand.
<div style="border: 1px solid black; padding: 5px; width: fit-content; margin: 0 auto;">Thermostat Ends Call for Heat</div> <div style="border: 1px solid black; padding: 5px; width: fit-content; margin: 0 auto;">Post-Purge</div>	  	PB _ _ _ CENTRAL HEATING 65 % 75 ° F	Call for heat ends. Post purge cycle for 30 seconds. Combustion Air Blower modulates to post purge setting.
<div style="border: 1px solid black; border-radius: 15px; padding: 5px; width: fit-content; margin: 0 auto;">Ready for Operation</div>	  	STANDBY: NO DEMAND 75 ° F	CH/System Pump, DHW pump, and Heat Exchanger Pump operate. Boiler returns to Standby Mode.

4 - CONTROL MODULE

4.5 Theory of Operation

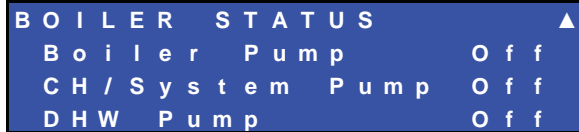
	User Interface Display	Explanation
STANDBY		<p>Boiler operates in standby mode until Central Heat (CH) or Domestic Hot Water (DHW) demand detected.</p> <p>Access User Menu by pressing 'Menu' key on user interface.</p>
User Menu		
User Menu		<p>User Menu structure. Use scroll keys to move to desired menu, and press Enter.</p> <ul style="list-style-type: none"> 'Boiler Status' submenu 'Settings' submenu – View CH , DHW supply water set point. 'Cascade Status' submenu – Boiler set to function as part of multiple boiler installation; submenu used to view runtime parameters. See Multiple Boiler Manual.
Boiler Status		<p>Supply Temperature set point displayed.</p> <p>CH set point displayed if boiler running in CH mode.</p> <p>Note: Value may change in proportion to outdoor temperature when running in Outdoor Reset mode.</p> <p>DHW supply set point displayed if boiler is running in DHW mode.</p>
		<p>← Water Temperature leaving boiler.</p> <p>← Water Temperature entering boiler.</p> <p>← DHW Thermostat (open or closed)</p>
		<p>← System Water Temperature (if used)</p> <p>← Vent System Temperature</p> <p>← Outdoor Temperature (if used)</p>
		<p>← Heat Exchanger Pump status (On or Off)</p> <p>← CH/System Pump status (if used, On or Off)</p> <p>← DHW Pump status (if used, On or Off)</p>

4 - CONTROL MODULE

	User Interface Display	Explanation
Settings	<p>S E T T I N G S</p> <p>C e n t r a l H e a t i n g</p> <p>S e t p o i n t ° F ▼</p> <p>Setting Range: 104° F to 195° F (40° C to 91° C) Default Value: 140° F (60° C)</p>	<p>Adjust CH set point to hydronic system design while in Operating in CH Mode = 0 (CH with Thermostat) or 3 (Permanent Demand).</p> <p>In CH Mode = 1 (CH with Thermostat and Outdoor Reset) or 2 (CH with Full Outdoor Reset). Display will change to 'OD Reset Setpoint' and cannot be changed. Control Module calculates set point based on outdoor temperature.</p>
	<p>S E T T I N G S</p> <p>D H W S e t p o i n t ° F ▼</p> <p>Setting Range: 104° F to 195° F (40° C to 91° C) Default Value: 180° F (82° C)</p>	<p>DHW set point determines supply water temperature set point when operating in DHW mode.</p> <p>Contact qualified agency to make changes.</p>
	<p>S E T T I N G S</p> <p>C h a n g e</p> <p>T e m p e r a t u r e U n i t s</p> <p>F a h r e n h e i t ° F ▼</p>	<p>Select temperature unit of measure.</p> <p>Fahrenheit °F or Celsius °C.</p>

5 - TROUBLE SHOOTING

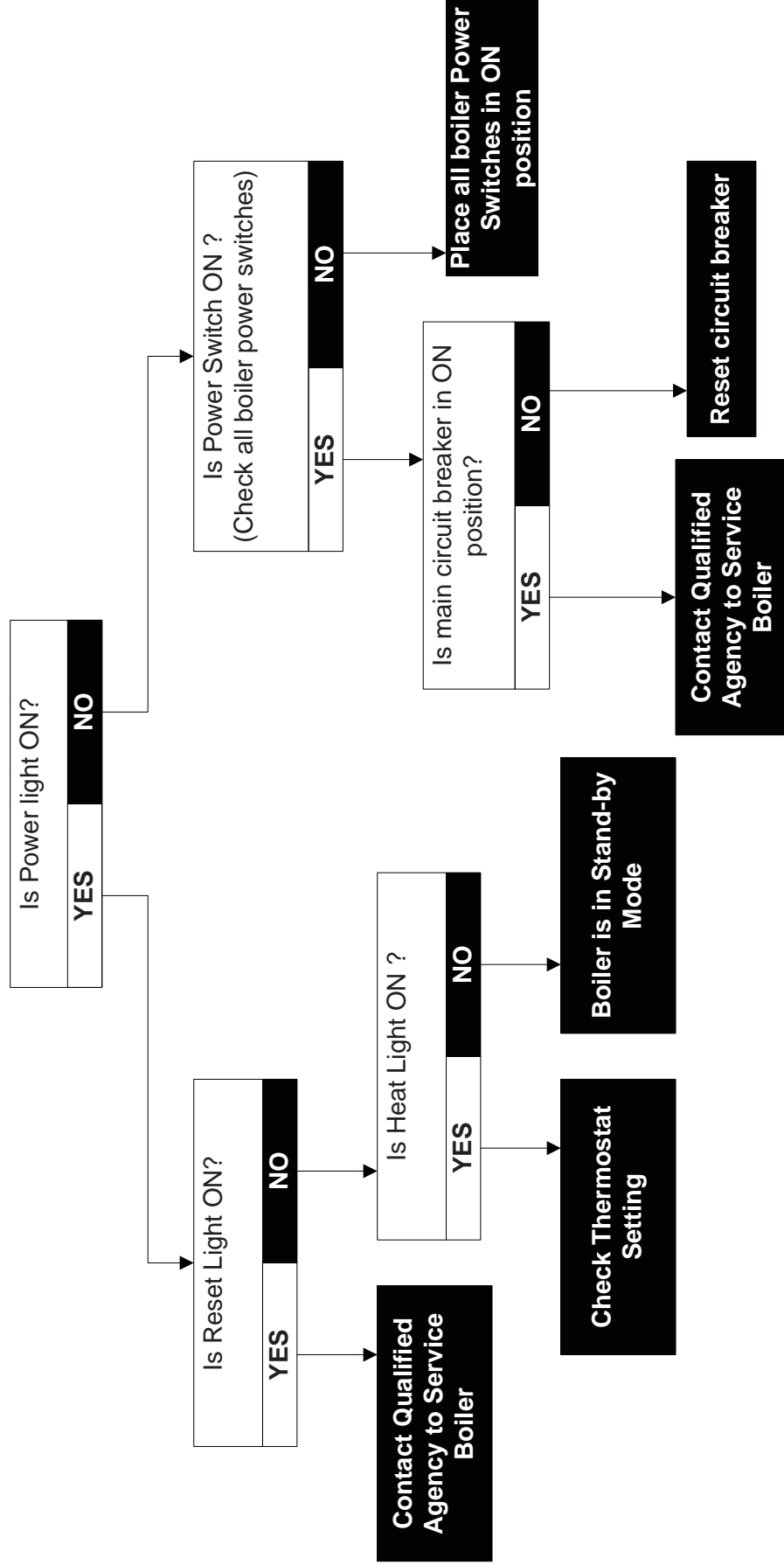

6 - MAINTENANCE

⚠ WARNING

Asphyxiation hazard. Contact qualified agency if condensate trap is not filled with water.

FIGURE 6-1 Condensate Drain

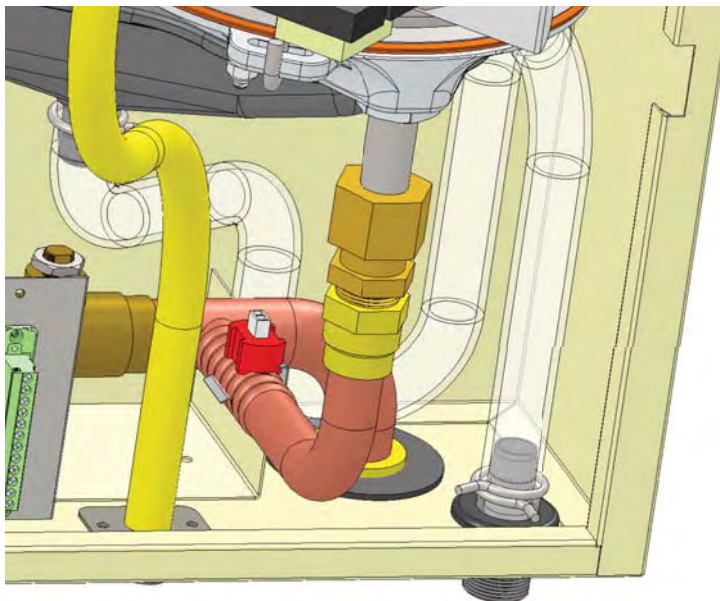
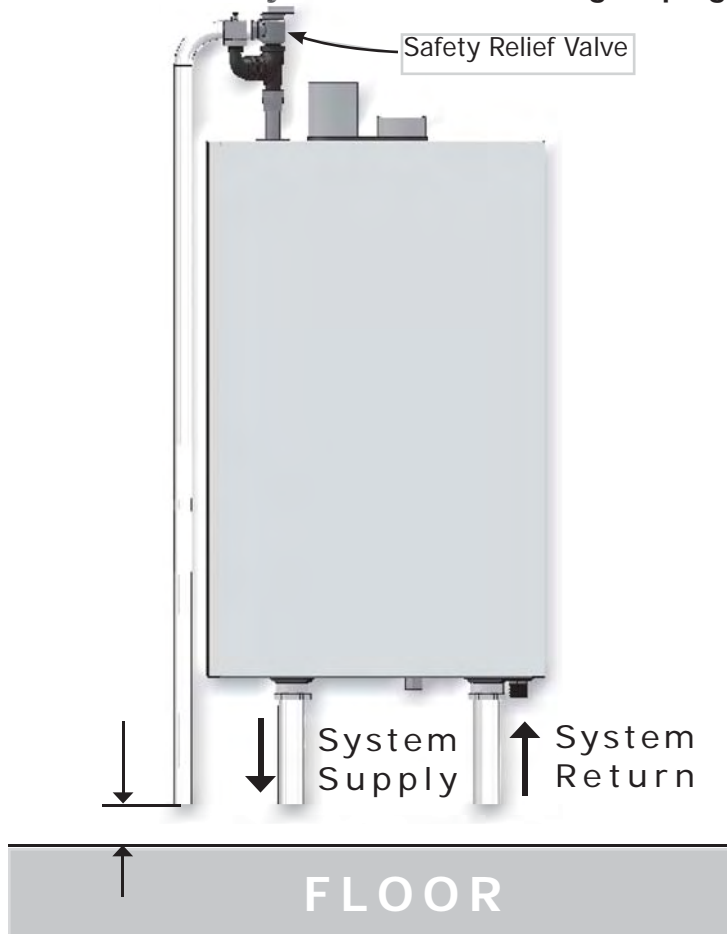

FIGURE 6-2 Safety Relief Valve Discharge Piping



Check Local Codes For Maximum Distance To Floor

Perform general housekeeping and maintenance as specified below.

6.1 Continuous

- Keep boiler area free from combustible materials, gasoline and other flammable vapors and liquids.
- Keep combustion air and vent terminations (outside building) free from trash, vegetation and other items capable of blocking flow.

6.2 Monthly

- Inspect combustion air, vent, and condensate drain piping for deterioration, leaks or sagging. Contact qualified agency, as necessary.
- Inspect condensate drain trap inside boiler.
 - Follow instructions TO TURN OFF GAS TO APPLIANCE. See section 2.
 - Inspect condensate drain trap for sediment or blockage. Contact qualified agency if cleaning required.
- Inspect system piping for leaks. Contact qualified agency, as necessary.
- Check air vent(s) for leakage.
- Follow OPERATING INSTRUCTIONS to return to normal operation.

6.3 Check According to Manufacturer's Instructions

- Safety Relief Valve - Refer to manufacturer's instructions.

⚠ WARNING

Burn and scald hazard. Verify Safety Relief Valve discharge piping run to safe discharge location before conducting maintenance procedure. Contact qualified agency to correct improper piping.

6.4 Annually or Beginning Each Heating Season

- Contact qualified agency to perform maintenance and cleaning per Installation, Operation and Maintenance manual. Inspection will include examining all flue product carrying areas, vent system, burner and heat exchanger. Will also include filling boiler with water if drained as part of End of Heating Season procedure.

6 - MAINTENANCE

6.5 End of Heating Season, if boiler not used for domestic hot water.

- Follow instructions to TURN OFF GAS TO APPLIANCE.
See section 2.
- Contact qualified agency to drain heating system (if system does not use antifreeze) and condensate trap if heating system is exposed to freezing temperatures while out of service.

Installer Information

Name:	
Address:	
Phone:	Email: