

# Cast Iron Gas-Fired Water Boiler

*Quality Engineered for Efficiency and Dependability*

*MGB Series*



# Warm-Up To Higher Efficiency With The MGB

The MGB Series boiler features an advanced heat exchanger design that utilizes atmospheric burners allowing it to be vented vertically through a chimney. This heat exchanger design combined with quality components such as a flue damper and electronic ignition helps the MGB achieve fuel efficiencies up to 84.1%, making it an ideal choice for new or existing homes.



## Quality Cast Iron Heat Exchanger

The MGB utilizes cast iron construction because of its durability and efficient heat

transfer capabilities. Cast iron sections and push nipples are an integral part of each MGB heat exchanger. Dual thermal flow speeds heat transfer. Hot flueway gases pass around hundreds of staggered studs on the flueway wall, providing rapid heat transfer to the boiler water.

Internal baffles agitate the circulating water, so it heats quickly and uniformly. Using only the highest quality cast iron and heat transfer designs ensure that the MGB will provide many years of efficient and trouble-free operation.

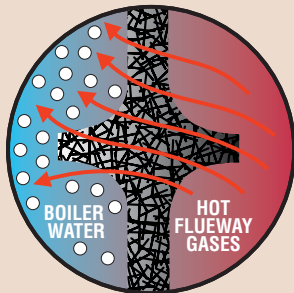

## Compare The Difference High Efficiency Makes

With efficiency ratings as high as 84.1%, the MGB provides increased energy savings resulting in lower fuel bills.

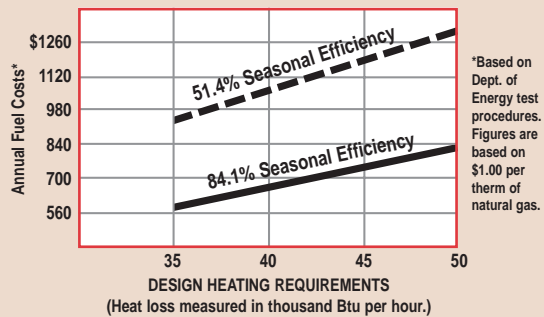

This graph illustrates the difference in annual operating costs between boilers with higher and lower efficiencies. Boilers installed years ago have seasonal efficiencies as low as 50%. So, your savings in fuel dollars with Utica's MGB boiler can repay its installed cost in a few short years!

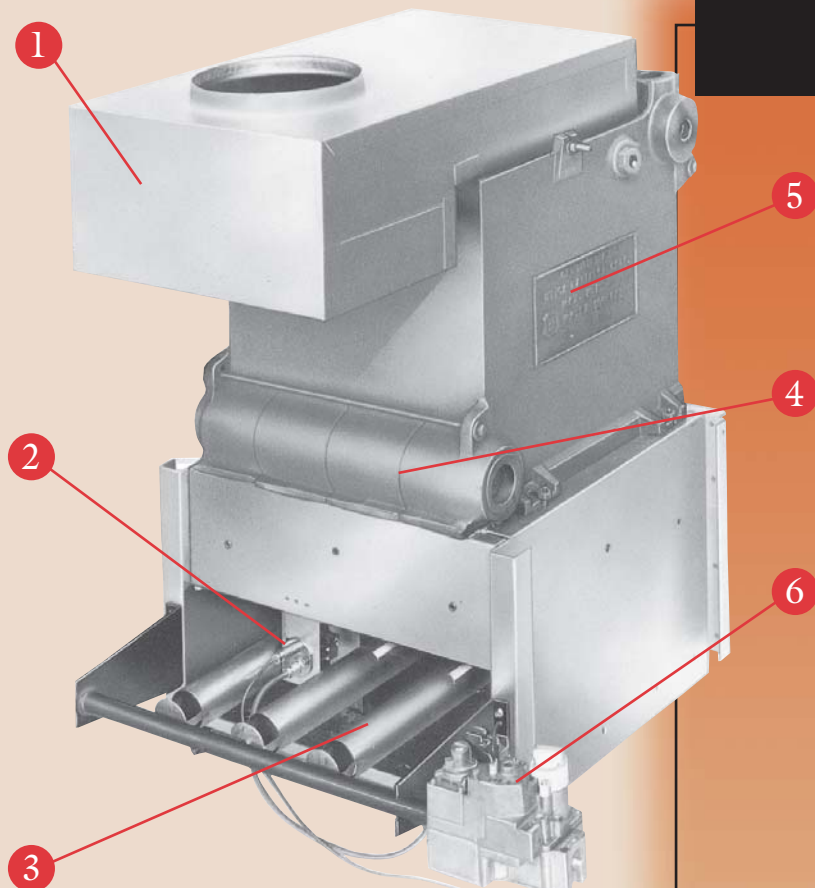





## Fuel Saving Components

Advanced engineering can be found in every part of an MGB boiler. An optional “on-demand” ignition control eliminates wasted fuel associated with a continuously burning pilot light. In addition, an integrated automatic vent damper closes when the burner shuts off, preventing heat from leaving through the chimney saving fuel and heating costs.

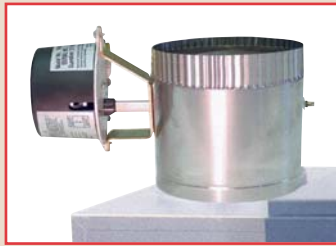

## Easy Installation and Maintenance

A compact design and special packaging features make the MGB boiler easy to install and service. An integrated flue collector and draft hood allows for easier installation in cramped areas. The pilot assembly is easily accessible, located on the orifice side of the burners, out of the main combustion area. The MGB comes factory-assembled, wired and tested to eliminate costly field assembly and reduce installation time.

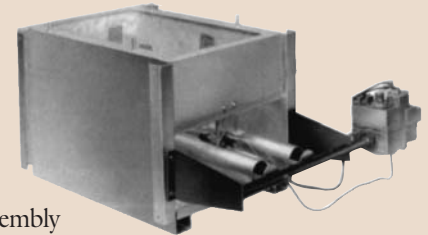

## Stainless Steel Burners

Corrosion resistant atmospheric stainless steel burners are incorporated into each MGB boiler delivering uniform flame patterns that optimize combustion efficiency and quiet operation.

## Manufacturers Limited Lifetime Warranty

Utica Boilers backs its residential, cast-iron heat exchangers with a Limited Lifetime Warranty. This Warranty is meant to protect your investment, but is also offered to illustrate our commitment to customer satisfaction.

## MGB Boiler Details.

- 1 Integrated Draft Hood
- 2 Pilot Assembly
- 3 Corrosion Resistant Atmospheric Stainless Steel Burners
- 4 Cast-Iron Push Nipples
- 5 Cast-Iron Heat Exchanger
- 6 Gas Valve

## Key MGB Boiler Features

- Cast-iron sections and push nipples
- Automatic Stack Damper
- Corrosion resistant stainless steel burners
- Energy Efficiency Ratings up to 84.1%
- Standard Pilot or Electronic Ignition
- Integral draft hood, natural draft chimney vented

# MGB Series Gas-Fired/Natural or Propane

BOILER NO.	A.G.A. INPUT BTU/HR.	HEATING CAPACITY BTU/HR.	I=B=R** NET OUTPUT BTU/HR.	NATURAL* GAS INLET	DIMENSIONS						PUMP SIZE SUPPLY & RETURN TAPPINGS	NO. OF BURNERS	ANNUAL FUEL UTILIZATION EFFICIENCY (AFUE)	
					A	B	C	D	E	F			ELECT. IGN. & DAMPER	STD. PILOT & DAMPER
MGB-50	50,000	42,000	37,000	1/2"	11 1/8"	5 1/2"	4"	30 3/4"	36 1/4"	6"	1 1/4"	1	84.1	80.0
MGB-75	75,000	63,000	55,000	1/2"	15"	7 1/2"	5"	30 3/4"	37 3/4"	6"	1 1/4"	2	83.1	80.0
MGB-100	100,000	83,000	72,000	1/2"	15"	7 1/2"	6"	30 3/4"	37 1/4"	6 1/2"	1 1/4"	2	83.0	80.0
MGB-125	125,000	104,000	90,000	1/2"	18 7/8"	9 1/2"	6"	30 3/4"	37 1/4"	6 1/2"	1 1/4"	3	82.0	80.0
MGB-150	150,000	124,000	108,000	1/2"	18 7/8"	9 1/2"	7"	30 3/4"	37 3/4"	7"	1 1/4"	3	83.0	80.0
MGB-175	175,000	143,000	124,000	1/2"	22 3/4"	11 3/8"	7"	30 3/4"	38 3/4"	7"	1 1/4"	4	81.0	80.0
MGB-200	200,000	165,000	143,000	1/2"	22 3/4"	11 3/8"	8"	30 3/4"	38 3/4"	8"	1 1/4"	4	81.9	80.0
MGB-250	250,000	205,000	178,000	3/4"	26 5/8"	13 1/4"	8"	32 3/4"	40 3/4"	8"	1 1/4"	5	80.5	80.0
MGB-300	299,999	243,000	214,000	3/4"	30 1/2"	15 1/4"	9"	32 3/4"	42 3/4"	10"	1 1/4"	6	80.0	80.0

\* Propane Gas Inlet, all units, 1/2" \*\* For equivalent square feet of radiation, divide I=B=R output by 150.

STANDARD EQUIPMENT: Boiler jacket, cast iron section, combination aquastat relay, theraltimeter gauge, circulator (field mounted), main gas burners, combination 24-volt gas control (includes automatic gas valve, gas pressure regulator, automatic pilot, safety shutoff, pilot flow adjustment, pilot filter), A.S.M.E. relief valve, drain valve, spill switch, rollout switch, automatic vent damper.

OPTIONAL EQUIPMENT: Interrupted electronic ignition pilot system, combustible floor kit. Conversion Kits: Natural Gas to Propane or Propane to Natural Gas. High Altitude Conversion Kits also available.

MEA# 19-79 Vol. II

## Explanation Notes

All boilers are design-certified for installation on non-combustible floors.

For installation on any combustible floor, use combustible floor kit.

Recommended chimney height 20 feet. In special cases where conditions permit, chimney height may be reduced to 10 feet. Refer to the latest revision of NFGC Part II.

Electrical service to be 120 Volts, 15 Amps, 60 Hz.

Elevations above 2000 feet, ratings should be reduced at a rate of 4% for each 1000 feet above sea level.

Net I=B=R ratings include 15% allowance for normal piping and pickup load. Manufacturer should be consulted on installations having other than normal piping and pickup requirements.

Specifications and dimensions are subject to change without notice.

## Dimensions

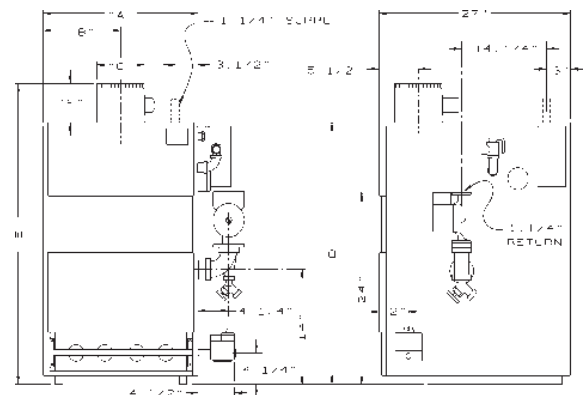

CSA Certified for Natural Gas or Propane

TESTED FOR 100 LBS. ASME WORKING PRESSURE

## Your Assurance Of Quality

Utica Boilers products are designed, tested, and assembled to ensure that you get the very best in home heating and cooling comfort, and value. Each one meets or exceeds all recognized safety, performance and efficiency standards.

**For more information on Utica Boilers beating products contact your local Utica Boilers distributor, or call the Utica Boilers Customer Service Department at 1-800-325-5479.**

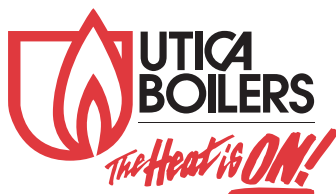

P.O. Box 4729 • Utica, New York 13504  
Tel. 315-797-1310 • Fax 866-432-7329  
Web Site: [www.utica boilers.com](http://www.utica boilers.com)  
E-mail: [sales@utica boilers.com](mailto:sales@utica boilers.com)

**USA Contractor Technical Assistance: 800-325-5479**

An ECR International Brand  
ISO 9001-2000 Certified Company

